

PHILIPS

hue personal
wireless
lighting

Enrave M
Devere M



HUE serial number



User manual
Benutzerhandbuch
Notice d'emploi
Manual de usuario
Manual do usuário
Manuale d'uso

Engrave M

Incl.



1 x CR2032 +

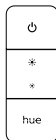

Excl.

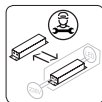
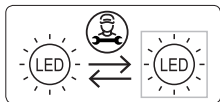
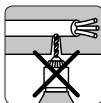
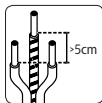
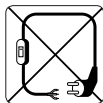
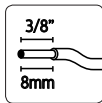
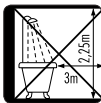
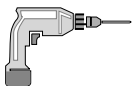

Devere M

Incl.



1 x CR2032

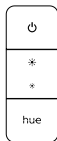

Excl.

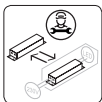
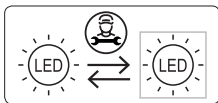
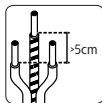
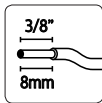
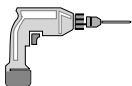

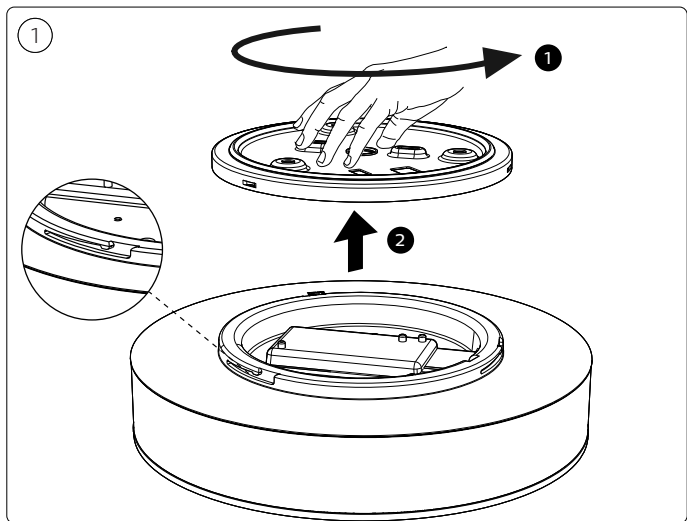
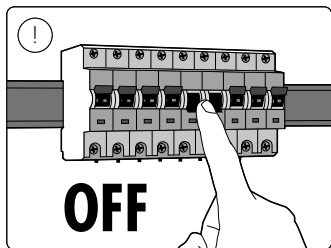

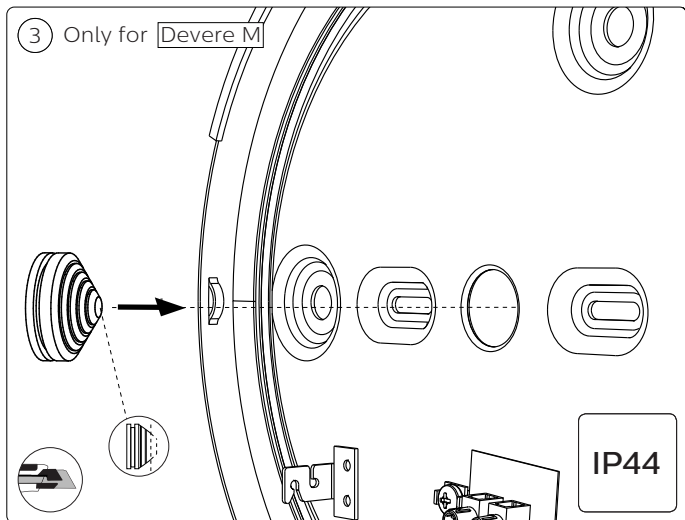
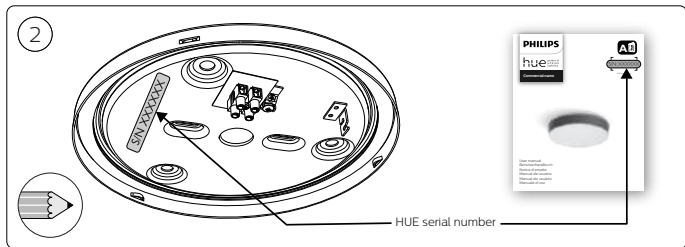

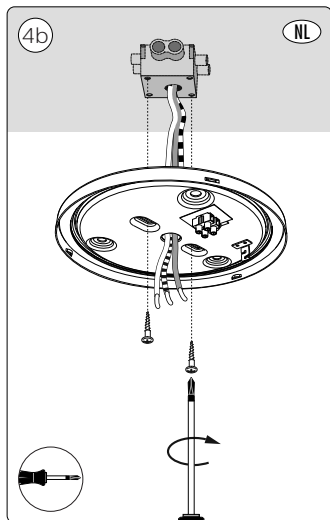
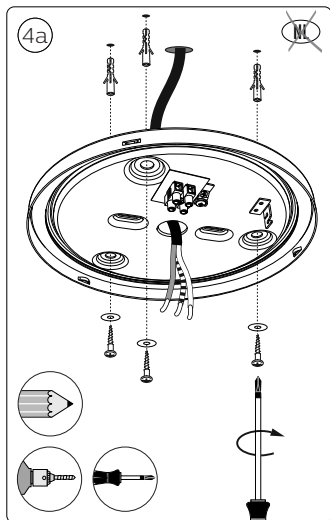

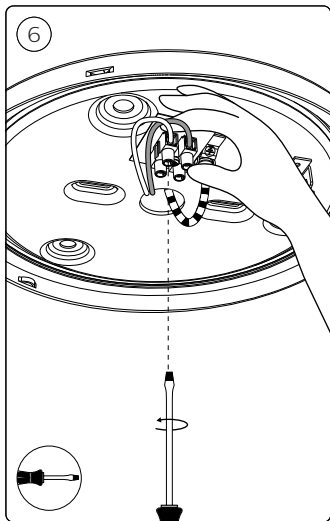
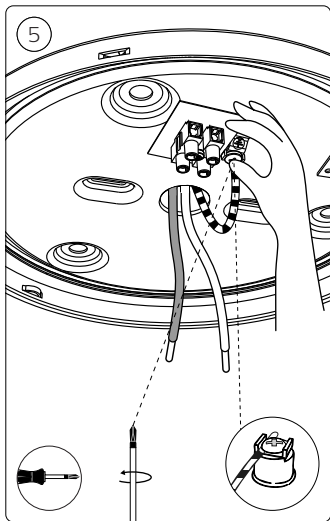

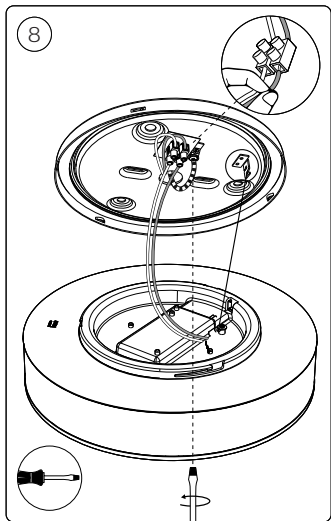
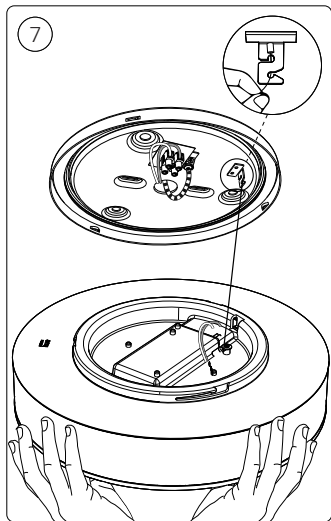

9a

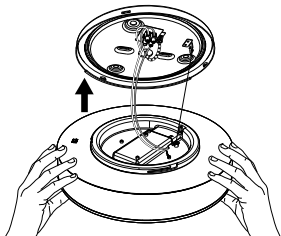

9b

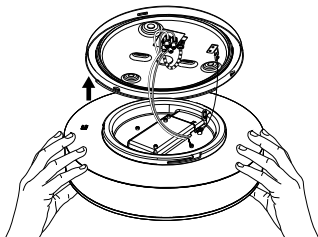

9c

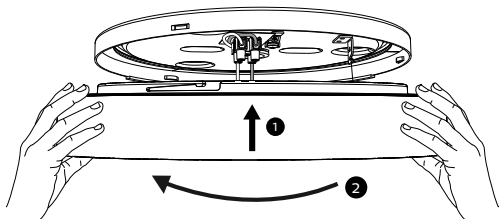

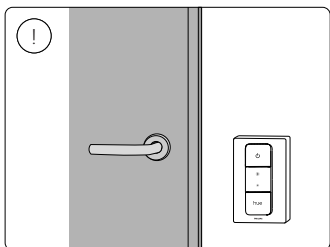
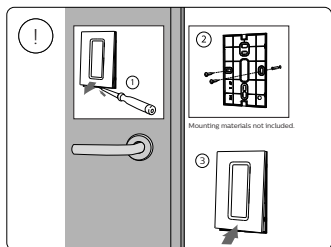
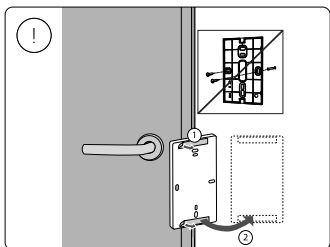
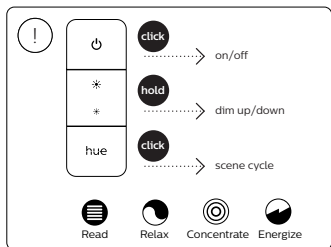
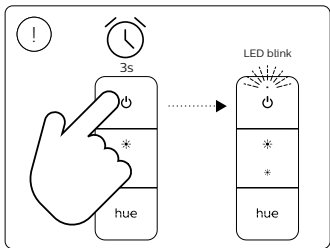
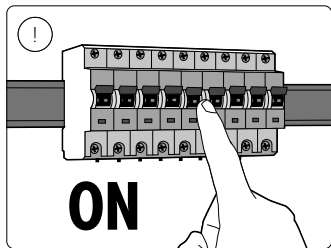

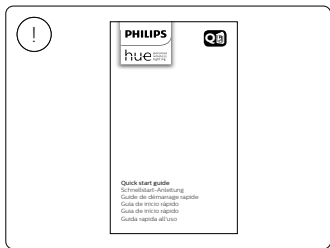
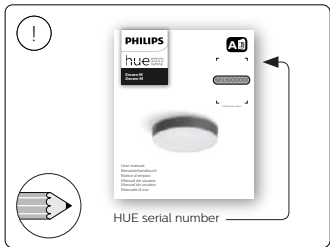
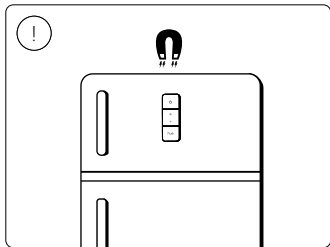



Signify
I.B.R.S. / C.C.R.I. Numéro 10461
5600 VB Eindhoven,
the Netherlands
☎00800-74454775

© 2021 Signify Holding
All rights reserved

www.philips-hue.com

4422 954 79992
Last update: 11/2021